

Project Name:	Type:
Part Number:	Date:

SPECFIT 4" NEW CONSTRUCTION

SPECIFICATION FEATURES

- **Mechanical** - Galvanized steel plaster frame. Low profile bar hangers with non-pass through construction and leveling flanges contain integral tee bar clip and preinstalled nail. Bar hangers are adjustable from 13-1/4" to 24-1/2" and can be installed in suspended T-Grid or wood joist ceilings. Attached junction box with quick connect MC cable allows for easy fixture wiring. The reflector's spring action clips allow for a secure installation in ceilings from 1/2" to 2" thick. The reflector opening allows a $\pm 5^\circ$ adjustability for perfect ceiling alignment.
- **Electrical** - Two selectable lumen output driver options with SelectDrive technology. The 120V, 50/60 Hz driver is forward or reverse phase dimmable to 5%. The 120-277V, 50/60 Hz driver is 0-10V dimmable to 5% with a low end cutoff and comes with a 12V auxiliary port that provides power for field installed sensors and control modules. Static lumen output driver options include the Signify Xitanium 1% dimming driver as well as the Lutron 5-Series Ecosystem driver which provides smooth dimming to 5% and the Lutron Hi-Lume 1% EcoSystem driver with Soft-On, Fade-to-Black which dims to 1%. EldoLED ECOdrive and SOLoDrive drivers are available in 0-10V and DALi configurations and dim smoothly to 1% and 0.1% respectively. Enlighted compact sensors and Philips EasySense sensors are field installable and directly integrate with the factory provided Philips Xitanium driver and Sensor Ready Bridge.
- **Optical** - Injection molded polycarbonate reflector, with post plating and painting treatment. 42° optical cutoff. Field interchangeable optical lenses. Four beam distributions. Wall wash field installed accessory. COB LED binned to 3-step SDCM to ensure color uniformity in 2700K, 3000K, 3500K, 4000K or 5000K CCT. Minimum 90 CRI. 97 CRI with TRUE CHROMA available in 3000K only.
- **Thermal** - Die cast heat sink. L70 lifetime of 100,000 hours. Fixture operating temperature: -13°F to +95°F (-25°C to 35°C).
- **Compliance and Warranty** - ETL Listed for Damp locations. Suitable for exterior under canopy mounting when utilizing OUT Outdoor Debris Ingress Protection option. 5 year parts warranty for complete fixture. Optional 10 Year Extended Warranty available, subject to same terms, conditions and installation requirements as standard 5 Year Warranty.

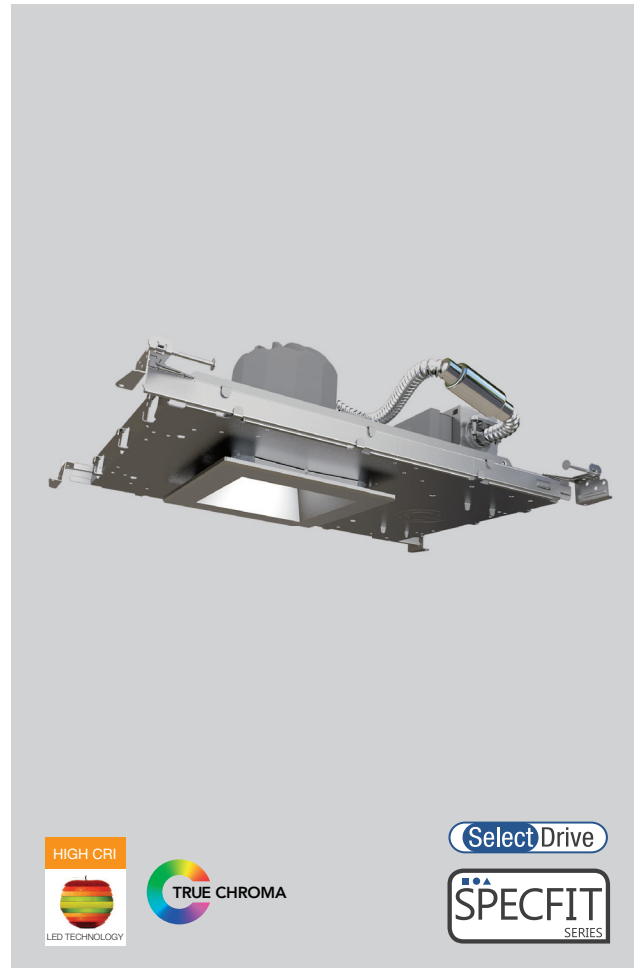

070221



BENEFITS

- Get the right amount of light with SelectDrive technology
- 42° optical cutoff reduces glare and make the space more comfortable
- Reflectors can be easily adjusted $\pm 5^\circ$ from below the ceiling
- Field interchangeable optics ensure smooth light levels
- Large variety of dimming and sensor control options
- Exceptional color rendering and uniformity

APPLICATIONS

- Commercial Office
- Hospitality
- Retail
- Educational
- Healthcare
- Exterior Under Canopy*

*Applicable with OUT Outdoor Debris Ingress Protection option.

DIMENSIONS

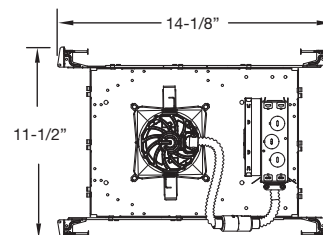
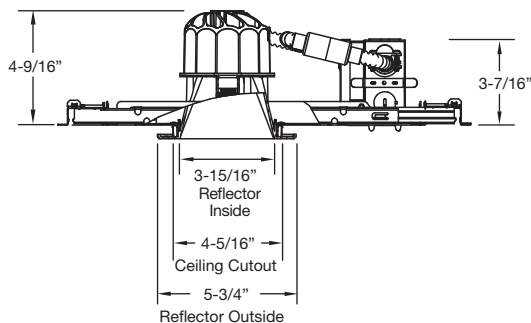



SPECFIT 4" NEW CONSTRUCTION

DIMENSIONS

with / Sensor

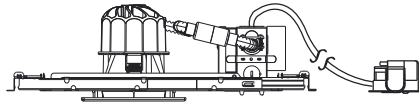

Philips EasySense sensor shown.
Enlighted compact sensor also available.

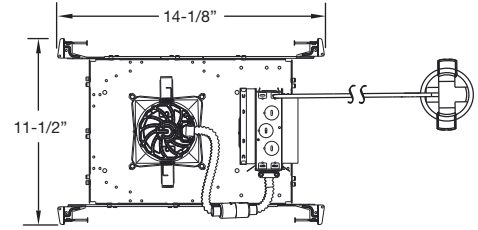

with / EM

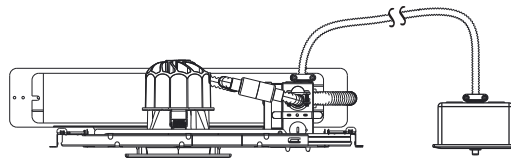

EM Test Switch shown.
Single gang j-box by others.

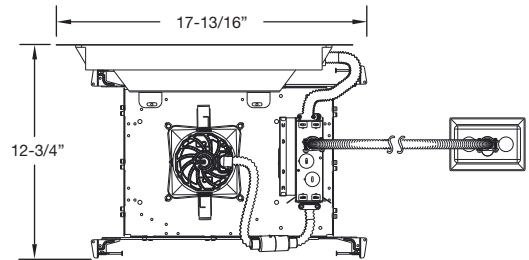

ORDERING EXAMPLE

A complete fixture consists of one light engine and one reflector.

SelectDrive Light Engine: SPFTS4/LE9035/KDIM010UNV/MD/OUT/EM
Reflector: ADS4CC

SelectDrive Light Engines

Frame Housing	Light Engine	CRI	CCT	Driver	Optical Distribution	Options ⁷
<input type="checkbox"/> SPFTS4 SPECFIT Square New Construction 4"	<input type="checkbox"/> LES Small Light Engine 500-700-1000 lumens	<input type="checkbox"/> 90 90+ CRI	<input type="checkbox"/> 27 2700K	<input type="checkbox"/> KDIM120V SelectDrive 120V, 50/60Hz Forward/Reverse Phase 10% dimming	<input type="checkbox"/> MD¹ Medium (Installed Standard) 60° Beam angle	<input type="checkbox"/> SD347 347V - 240V Step Down Transformer
	<input type="checkbox"/> LEM Medium Light Engine 1500-2000-2500 lumens	<input type="checkbox"/> 97³ 97 CRI 3000K True Chroma	<input type="checkbox"/> 30 3000K	<input type="checkbox"/> KDIM010UNV² SelectDrive 120-277V, 50/60Hz 0-10V dimming	<input type="checkbox"/> VN Very Narrow 25° Beam angle	<input type="checkbox"/> EM⁴ 10W Pre-installed Emergency Backup
			<input type="checkbox"/> 35 3500K		<input type="checkbox"/> NR Narrow 40° Beam angle	<input type="checkbox"/> EM⁴-CEC 10W Pre-installed Emergency Backup California Compliant
			<input type="checkbox"/> 40 4000K		<input type="checkbox"/> WD Wide 75° Beam angle	<input type="checkbox"/> OUT Outdoor Debris Ingress Protection
			<input type="checkbox"/> 50 5000K			

Reflectors

Shape	Finish
<input type="checkbox"/> ADS4 4" Square Reflector	<input type="checkbox"/> CC Clear Diffuse Trim and Flange <input type="checkbox"/> WH Matte White Trim and Flange

¹ Medium Lens Optic comes installed as standard, if other optic distribution selected the lens will ship separately and require field installation. / ² Dims to 5% with low end cutoff. Dimmer compatibility available on website. / ³ CRI97 TRUE CHROMA is only available in 3000K only. It is made to order (MTO) for the lumen values of 3000 and above, including the LEL light engine. / ⁴ EM cannot be combined with SD347 or SD480 option / ⁷ Options are factory installed and come with the Light Engine and Driver.

SPECFIT 4" NEW CONSTRUCTION

ORDERING EXAMPLE

A complete fixture consists of one light engine and one reflector.

Philips Light Engine W/ Enlighted Micro Sensor: SPFTS4/LE25/9040/PSRUNV/VN/ENLS-IOT Reflector: ADS4CC	Lutron EcoSystem Light Engine: SPFTS4/LE15/9027/LUT-5UNV/NR Reflector: ADS4BL
Philips Light Engine W/ EasySense Sensor: SPFTS4/LE10/9030/PSRUNV/VN/ES Reflector: ADS4CW	EldoLED Light Engine SOLOdrive: SPFTS4/LE20/9035/ELD-S010UNV/WD Reflector: ADS4WH

ORDERING INFORMATION

Fixed Output Light Engines

Frame Housing	Light Engine	CRI	CCT	Driver	Optical Distribution	Options ⁷
<input type="checkbox"/> SPFTS4 SPECFIT Square New Construction 4"	<input type="checkbox"/> LE05⁸ 500 lumens	<input type="checkbox"/> 90 90+CRI	<input type="checkbox"/> 27 2700K	<input type="checkbox"/> PSRUNV Signify 0-10V Driver + Sensor Ready Bridge, 1% Dimming, 120-277V	<input type="checkbox"/> MD¹ Medium (Installed Standard) 60° Beam angle	<input type="checkbox"/> SD347 347V - 240V Step Down Transformer
	<input type="checkbox"/> LE07 700 lumens	<input type="checkbox"/> 97³ 97 CRI 3000K True Chroma	<input type="checkbox"/> 30 3000K	<input type="checkbox"/> LUT-1UNV Lutron EcoSystem 1% Dimming, 120-277V	<input type="checkbox"/> VN Very Narrow 25° Beam angle	<input type="checkbox"/> EM⁴ 10.7W Emergency Backup
	<input type="checkbox"/> LE10 1,000 lumens		<input type="checkbox"/> 35 3500K	<input type="checkbox"/> LUT-5UNV Lutron EcoSystem 5% Dimming, 120-277V	<input type="checkbox"/> NR Narrow 40° Beam angle	<input type="checkbox"/> EM⁴ -CEC California Title 20 Compliant 10.7W Emergency Backup
	<input type="checkbox"/> LE15 1,500 lumens		<input type="checkbox"/> 40 4000K	<input type="checkbox"/> LUT-L3DUNV Lutron Hi-lume 3-Wire 1% Dimming, 120-277V	<input type="checkbox"/> WD Wide 75° Beam angle	<input type="checkbox"/> ES⁵ Philips EasySense ceiling mount sensor
	<input type="checkbox"/> LE20 2,000 lumens		<input type="checkbox"/> 50 5000K	<input type="checkbox"/> ELD-E010UNV EldoLED ECOdrive 0-10V 1%, 120-277V		<input type="checkbox"/> ENLS⁶-IL Enlighted Two Wire ENLIGHTED ONE Compact Sensor
	<input type="checkbox"/> LE25 2,500 lumens			<input type="checkbox"/> ELD-EDALIUNV EldoLED ECOdrive DALI 1%, 120-277V		<input type="checkbox"/> ENLS⁶-CL Enlighted Two Wire CONNECTED LIGHTING Compact Sensor
				<input type="checkbox"/> ELD-S010UNV EldoLED SOLOdrive 0-10V 0.1%, 120-277V		<input type="checkbox"/> ENLS⁶-IOT Enlighted Two Wire IOT Compact Sensor
				<input type="checkbox"/> ELD-SDALIUNV EldoLED SOLOdrive DALI 0.1%, 120-277V		<input type="checkbox"/> OUT Outdoor Debris Ingress Protection
				<input type="checkbox"/> XT010UNV Signify 0-10V Driver 1% Dimming, 120-277V		

Reflectors

Shape	Finish
<input type="checkbox"/> ADS4 4" Square Reflector	<input type="checkbox"/> CC Clear Diffuse Trim and Flange <input type="checkbox"/> WH Matte White Trim and Flange

¹ Medium Lens Optic comes installed as standard, if other optic distribution selected the lens will ship separately and require field installation / ³ CRI97 TRUE CHROMA is only available in 3000K only. It is made to order (MTO) for the lumen values of 3000 and above, including the LEL light engine. / ⁴ EM cannot be combined with SD347 or SD480 option / ⁵ Philips EasySense ceiling mounted sensor is only available with the PSRUNV driver. / ⁶ Enlighted Two Wire Compact Sensor with ceiling mount is only available with the PSRUNV driver. / ⁷ Options are factory installed and come with the Light Engine and Driver.
/ ⁸ LE05 is not available with LUT-5UNV.



SPECFIT 4" NEW CONSTRUCTION

ACCESSORY ORDERING INFORMATION				
Product	Model	Description	Pictures	Dimensions
98079	ADWAW	Wall Wash (Field Installed on Lens)		
35126	NCFBFB	Set of Two Field Installable Butterfly Brackets For New Construction Rough-in Frame		
35125	NCFEMB	Field Installable Emergency Bracket For New Construction Rough-in Frame		

10 YEAR EXTENDED WARRANTY

Model	SPFTS4 / LE _{xx} / 10YEARWARRANTY*
<p>*Where xx = Fixture Light Engine lumen output designation. Example: 10 Year Warranty Part Number for SPFTS4/LEM or SPFTS4/LE20 Light engine is SPFTS4/LEM/10YEARWARRANTY and SPFTS4/LE20/10YEARWARRANTY respectively.</p>	



SPECFIT 4" NEW CONSTRUCTION

TECHNICAL INFORMATION

Light Engine	Input Voltage	Input Frequency	Input Current	Input Power	THD Power	Power Factor
LESXXXX	120 / 277V	50 / 60Hz	0.115 / 0.047A	13W	<20%	>0.9
LEMXXXX	120 / 277V	50 / 60Hz	0.270 / 0.114A	31.5W	<20%	>0.9
LE05XXXX	120 / 277V	50 / 60Hz	0.056 / 0.024A	6.5W	<20%	>0.9
LE07XXXX	120 / 277V	50 / 60Hz	0.073 / 0.034A	8.5W	<20%	>0.9
LE10XXXX	120 / 277V	50 / 60Hz	0.112 / 0.047A	13W	<20%	>0.9
LE15XXXX	120 / 277V	50 / 60Hz	0.154 / 0.068A	18W	<20%	>0.9
LE20XXXX	120 / 277V	50 / 60Hz	0.218 / 0.092A	25.5W	<20%	>0.9
LE25XXXX	120 / 277V	50 / 60Hz	0.269 / 0.116A	31.5W	<20%	>0.9

NOMINAL PERFORMANCE

LES (LE05 / LE07 / LE10) - Low / Medium / High - 6.5 / 8.5 / 12.5W

CCT	2700K			3000K			3500K			4000K			5000K		
	Low	Medium	High	Low	Medium	High	Low	Medium	High	Low	Medium	High	Low	Medium	High
Output**	Im LPW	Im LPW	Im LPW	Im LPW	Im LPW	Im LPW	Im LPW	Im LPW	Im LPW	Im LPW	Im LPW	Im LPW	Im LPW	Im LPW	Im LPW
Finish	Im LPW	Im LPW	Im LPW	Im LPW	Im LPW	Im LPW	Im LPW	Im LPW	Im LPW	Im LPW	Im LPW	Im LPW	Im LPW	Im LPW	Im LPW
Clear Diffuse	500 77	700 82	1,000 80	525 81	735 86	1,050 84	550 85	770 91	1,100 88	575 88	805 95	1,150 92	580 89	810 95	1,165 93
White	495 76	693 82	990 79	520 80	728 86	1,040 83	545 84	762 90	1,089 87	569 88	797 94	1,139 91	574 88	802 94	1,153 92

** Lumen output are based on rated lumens, for exact value please refer to the IES files

LEM (LE15 / LE20 / LE25) - Low / Medium / High - 18.0 / 25.5 / 31.5W

CCT	2700K			3000K			3500K			4000K			5000K		
	Low	Medium	High	Low	Medium	High	Low	Medium	High	Low	Medium	High	Low	Medium	High
Output**	Im LPW	Im LPW	Im LPW	Im LPW	Im LPW	Im LPW	Im LPW	Im LPW	Im LPW	Im LPW	Im LPW	Im LPW	Im LPW	Im LPW	Im LPW
Finish	Im LPW	Im LPW	Im LPW	Im LPW	Im LPW	Im LPW	Im LPW	Im LPW	Im LPW	Im LPW	Im LPW	Im LPW	Im LPW	Im LPW	Im LPW
Clear Diffuse	1,600 89	2,125 83	2,500 79	1,632 91	2,169 85	2,550 81	1,664 92	2,210 87	2,600 83	1,696 94	2,253 88	2,650 84	1,713 95	2,275 89	2,677 85
White	1,584 88	2,104 82	2,475 78	1,616 90	2,147 84	2,525 80	1,647 91	2,188 86	2,574 82	1,679 93	2,230 87	2,624 83	1,696 94	2,252 88	2,650 84

** Lumen output are based on rated lumens, for exact value please refer to the IES files



SPECFIT 4" NEW CONSTRUCTION

PHOTOMETRY

SPFST4-LES9035-KDIM010-UNV-VN-ADS4CC

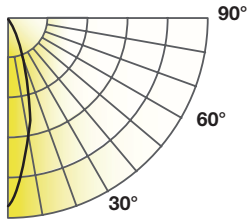

Lumens: 1,192 lm
CBCP: 4,352 cd
Power: 11 W
Efficacy: 95 lm/W
CRI: 90+
Spacing Criteria: 0.42
Beam Angle: 25°

Candlepower Distribution		Initial Footcandles			Zonal Lumen Summary		
Angle (°)	Average (cd)	Height (ft)	Fc	Diameter (ft)	Zone	Lumens	%Fixt
10	2,588	4	240	1.8	0-30	1,081	91%
20	1,190	6	107	2.7	0-40	1,153	97%
30	240	8	60	3.6	0-60	1,190	100%
40	60	10	38	4.5	0-90	1,191	100%
50	19	12	27	5.4			
60	3						
70	0						
80	0						
90	0						

SPFST4-LES9035-KDIM010-UNV-NR-ADS4CC

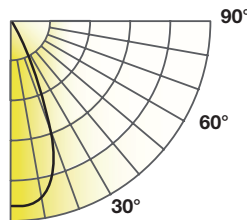

Lumens: 1,224 lm
CBCP: 2,395 cd
Power: 11 W
Efficacy: 99 lm/W
CRI: 90+
Spacing Criteria: 0.62
Beam Angle: 43°

Candlepower Distribution		Initial Footcandles			Zonal Lumen Summary		
Angle (°)	Average (cd)	Height (ft)	Fc	Diameter (ft)	Zone	Lumens	%Fixt
10	2,194	4	204	3.1	0-30	1,092	89%
20	1,445	6	91	4.7	0-40	1,196	98%
30	396	8	51	6.3	0-60	1,223	100%
40	55	10	33	7.8	0-90	1,224	100%
50	12	12	23	9.4			
60	2						
70	0						
80	0						
90	0						

SPFST4-LES9035-KDIM010-UNV-MD-ADS4CC

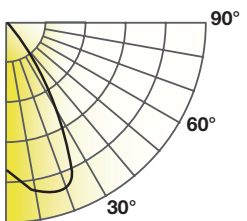

Lumens: 1,243 lm
CBCP: 1,412 5cd
Power: 11 W
Efficacy: 100 lm/W
CRI: 90+
Spacing Criteria: 0.94
Beam Angle: 64°

Candlepower Distribution		Initial Footcandles			Zonal Lumen Summary		
Angle (°)	Average (cd)	Height (ft)	Fc	Diameter (ft)	Zone	Lumens	%Fixt
10	1,277	4	119	5.0	0-30	953	77%
20	1,283	6	53	7.4	0-40	1,195	96%
30	667	8	30	9.9	0-60	1,242	100%
40	135	10	19	12.4	0-90	1,243	100%
50	13	12	13	14.9			
60	2						
70	0						
80	0						
90	0						



SPECFIT 4" NEW CONSTRUCTION

PHOTOMETRY

SPFTS4-LES9035-KDIM010-UNV-WD-ADS4CC

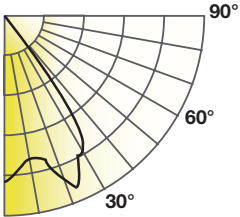

Lumens: 1,222 lm
CBCP: 930 cd
Power: 11 W
Efficacy: 98 lm/W
CRI: 90+
Spacing Criteria: 1.17
Beam Angle: 80°

Candlepower Distribution		Initial Footcandles			Zonal Lumen Summary		
Angle (°)	Average (cd)	Height (ft)	Fc	Diameter (ft)	Zone	Lumens	%Fixt
10	746	4	69	6.7	0-30	675	55%
20	795	6	31	10.1	0-40	1,094	90%
30	825	8	17	13.4	0-60	1,220	100%
40	425	10	11	16.8	0-90	1,222	100%
50	14	12	8	20.1			
60	4						
70	0						
80	0						
90	0						

SPFTS4-LEM9035-KDIM010-UNV-VN-ADS4CC

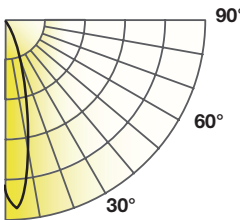

Lumens: 2,546 lm
CBCP: 9,353 cd
Power: 28W
Efficacy: 79 lm/W
CRI: 90+
Spacing Criteria: 0.43
Beam Angle: 27°

Candlepower Distribution		Initial Footcandles			Zonal Lumen Summary		
Angle (°)	Average (cd)	Height (ft)	Fc	Diameter (ft)	Zone	Lumens	%Fixt
10	746	4	69	1.9	0-30	2,303	91%
20	795	6	31	2.8	0-40	2,459	97%
30	825	8	17	3.8	0-60	2,540	100%
40	425	10	11	4.7	0-90	2,543	100%
50	14	12	8	5.7			
60	4						
70	0						
80	0						
90	0						

SPFTS4-LEM9035-KDIM010-UNV-NR-ADS4CC

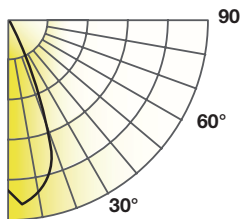

Lumens: 2,617lm
CBCP: 5,368 cd
Power: 28W
Efficacy: 81 lm/W
CRI: 90+
Spacing Criteria: 0.65
Beam Angle: 42°

Candlepower Distribution		Initial Footcandles			Zonal Lumen Summary		
Angle (°)	Average (cd)	Height (ft)	Fc	Diameter (ft)	Zone	Lumens	%Fixt
10	5,019	4	466	3.0	0-30	2,360	90%
20	3,021	6	207	4.6	0-40	2,558	98%
30	778	8	117	6.1	0-60	2,612	100%
40	103	10	75	7.6	0-90	2,614	100%
50	25	12	52	9.1			
60	4						
70	0						
80	0						
90	0						



SPECFIT 4" NEW CONSTRUCTION

PHOTOMETRY

SPFTS4-LEM9035-KDIM010-UNV-MD-ADS4CC

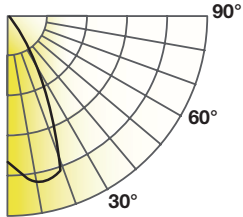

Lumens: 2,652 lm
CBCP: 3,068 cd
Power: 28 W
Efficacy: 82 lm/W
CRI: 90+
Spacing Criteria: 0.96
Beam Angle: 64°

Candlepower Distribution	
Angle (°)	Average (cd)
10	2,849
20	2,770
30	1,461
40	223
50	25
60	5
70	0
80	0
90	0

Initial Footcandles		
Height (ft)	Fc	Diameter (ft)
4	265	5.0
6	118	7.5
8	66	9.9
10	42	12.4
12	29	14.9

Zonal Lumen Summary		
Zone	Lumens	%Fixt
0-30	2,070	78%
0-40	2,565	97%
0-60	2,647	100%
0-90	2,650	100%

SPFTS4-LEM9035-KDIM010-UNV-WD-ADS4CC

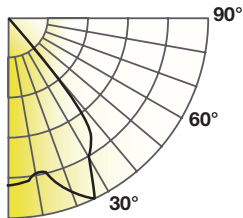

Lumens: 2,622 lm
CBCP: 2,070 cd
Power: 28 W
Efficacy: 81 lm/W
CRI: 90+
Spacing Criteria: 1.17
Beam Angle: 79°

Candlepower Distribution	
Angle (°)	Average (cd)
10	1317
20	1494
30	1591
40	1040
50	134
60	34
70	11
80	3
90	0

Initial Footcandles		
Height (ft)	Fc	Diameter (ft)
4	155	6.6
6	69	9.9
8	39	13.2
10	25	16.5
12	17	19.8

Zonal Lumen Summary		
Zone	Lumens	%Fixt
0-30	1,537	59%
0-40	2,385	91%
0-60	2,614	100%
0-90	2,620	100%